



**Electric Diffusers**



# Technology Innovation

Η διάχυση κρύου αέρα, επίσης γνωστή ως νεφελοποίηση, είναι μια τεχνολογία αιχμής που αναπτύχθηκε για τη διάχυση του αρώματος. Τα μηχανήματα που αξιοποιούν αυτήν την τεχνολογία χρησιμοποιούν φιλτραρισμένο κρύο αέρα στη θέση της θερμότητας για να διασπασούν το άρωμα σε μικροσωματίδια, που στη συνέχεια διανέμονται σε όλο το χώρο. Η διασπορά του αρώματος με κρύο αέρα είναι ο πιο ασφαλής και καθαρός τρόπος για να αρωματίσετε το χώρο σας. Αυτή η τεχνολογία επιτυγχάνει τη μέγιστη ποτελεσματικότητα, καθώς απαιτεί λιγότερο άρωμα από έναν παραδοσιακό διαχύτη για να αρωματίσει το ίδιο μέγεθος δωματίου. Τα μηχανήματα διαθέτουν προηγμένες ρυθμίσεις με Bluetooth, καλύπτοντας κάθε απαίτηση.

Cold air diffusion, also known as nebulization, is a state-of-the-art technology that has been developed to diffuse fragrances. The devices that utilize this technology use filtered cold air instead of heat to break down the fragrance into microparticles, which are then distributed throughout the space. Diffusing the perfume with cold air is the safest and cleanest way to scent your space. This technology achieves maximum efficiency, as it requires less fragrance than a traditional diffuser to scent the same area. The devices have advanced settings with Bluetooth, covering every requirement.

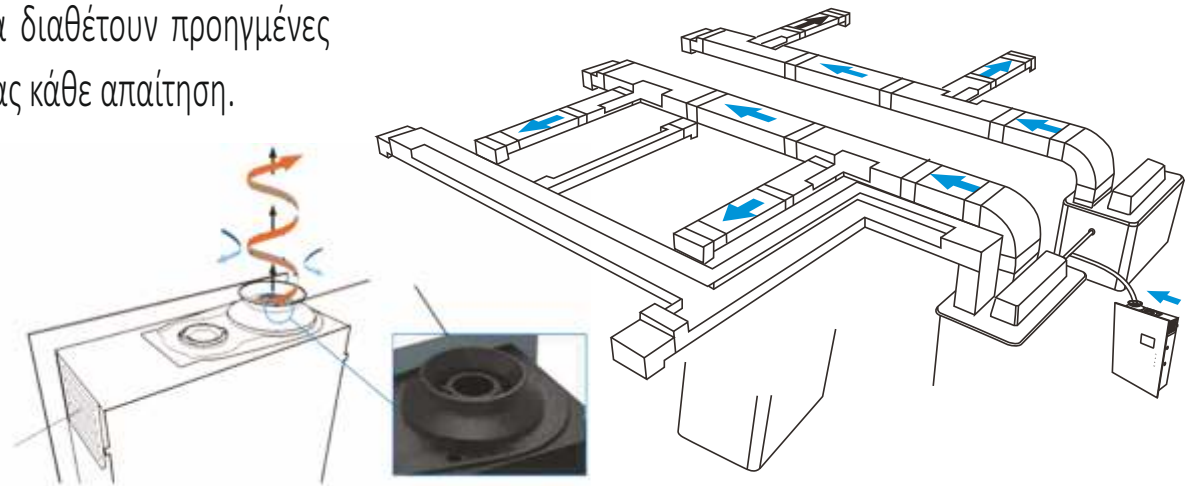







*Our Collection*

# Electric Diffusers

## A30

-  Safe lock design
-  Comfortable Scent
-  Decent design
-  Time programming
-  Anticorrosive plastic material

### Product Feature

- D-size alkaline battery
- Bluetooth APP
- Ten scent intensities for selection



### Wall - mounted





- D: 174\*156\*62.8mm
- Consumption:0.04-0.35g/h
- Bottle:100ml
- Coverage:30m<sup>2</sup>/100m<sup>3</sup>
- Color: White/Black
- Materials:PP+PET

### Details



# Electric Diffusers

## F125

-  Press Design
-  Time programming
-  Anticorrosive plastic material
-  Fast diffusion

### Product Feature

- Manual Control
- Personalized working modes
- Simple operation
- 4AA-size alkaline battery







### Wall - mounted/ Tabletop

- D: 174\*81\*61mm
- Consumption: Up to 0,42mL/h
- Bottle: 125 mL
- Coverage: 50m<sup>2</sup>/150m<sup>3</sup>
- Color: White/Black
- Anticorrosive PP



# Electric Diffusers

## AZ60

-  Two Spray Directions
-  Lasting fragrance
-  Bluetooth Connection
-  Time programming
-  Built-in fan

### Product Feature

- Personalized working modes
- Magnetic adsorption
- Simple operation



### Wall - mounted



- D: 185x77x132mm
- Consumption:0.04-0.66ml/h
- Bottle:250ml
- Coverage:60m<sup>2</sup>/180m<sup>3</sup>
- Color: White
- Materials:PP+PET





### Details





# Electric Diffusers

## F200

-  Low Noise
-  Press design
-  Built-in fan
-  Fast diffusion

### Product Feature

- Time programming
- Disposable bottle
- Customized modes (APP optional)
- Manual/Bluetooth/WIFI control







### Wall-Mounted / Tabletop

- D: 214\*154\*70mm
- Consumption: Up to 1.5mL/h
- Bottle: 200 mL
- Coverage: 170m<sup>2</sup>/500m<sup>3</sup>
- Color: White/Black
- Materials: Acrylic/PP



# Electric Diffusers

## S150

-  Generous design
-  Time programming
-  Sucker Design
-  Low Noise

### Product Feature

- Touch Screen / Bluetooth APP
- Twenty scent intensities
- Customized modes
- Input Voltage:DC12V



### Wall - mounted / Stand Alone Table Top / HVAC

- D: 205\*205\*87.2mm
- Consumption:0.08-1.2g/h
- Bottle:480 mL
- Coverage:150m<sup>2</sup>/450m<sup>3</sup>
- Color:Silver&White/  
Silver&Black
- Aluminum+Metal





### Details





# Electric Diffusers

## A400/A800

-  Safe lock design
-  Module Design
-  Anticorrosive plastic
-  Built-in fan
-  Time programming



Wall - mounted / Stand Alone / HVAC

### Product Feature

- Touch Screen / Bluetooth APP
- Input Voltage:DC12V
- Material: Plastic
- Color: White / Black
- D: 295\*222\*113mm
- Consumption:  
A400: 0.10-2.00ml/hr  
A800: 0.20-4.00ml/hr
- Bottle:850 mL
- Coverage:  
A400: 400m<sup>2</sup>/1200m<sup>3</sup>  
A800: 800m<sup>2</sup>/2400m<sup>3</sup>

### Details



# Electric Diffusers

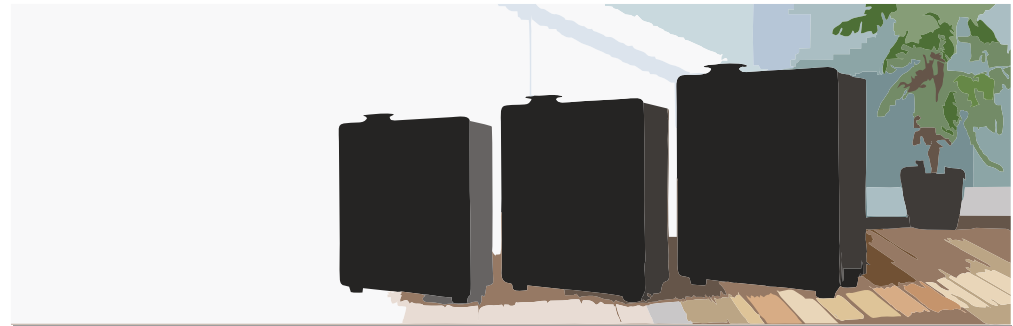

Wall - mounted / Stand Alone / HVAC

## A500/A1000

- Safe lock design
- Low Noise
- Bluetooth App
- Elegant design

- Built-in fan
- Time programming
- Plastic&Aluminum atomizer head





- Material: Metal+Glass
- Input Voltage:DC12V
- Color: White/Black  
White&Black

- D:A500: 206\* 99 \* 313mm  
A1000:236\*110\*363mm
- Consumption:  
A500: 0.13-2.54ml/h  
A1000: 0.25-5.00ml/h
- Bottle: A500: 500 mL  
A1000:1000 mL
- Coverage:  
A500: 500m<sup>2</sup>/1500m<sup>3</sup>  
A1000: 1000m<sup>2</sup>/3000m<sup>3</sup>



# Electric Diffusers

## S1600

-  Generous Design
-  Time programming
-  Low Noise
-  Built-in fan
-  Large Coverage

### Product Feature

- Large bottle capacity
- Touch Screen / Bluetooth APP
- Twenty scent Intensities
- HVAC connecting
- Customized modes (APP optional)
- Input Voltage:DC12V



### Stand Alone / HVAC

- D: 167\*162\*222mm
- Consumption:0.50-5.50ml/hr
- Bottle:5000 mL
- Coverage:1600m<sup>2</sup>/5000m<sup>3</sup>
- Color: Black/White
- Materials:Aluminum + Acrylic

### Details





TOPSTOP & SIA L.P.  
35str Manou Katraki  
Heraklion-Crete-Greece  
Tel: +302810254580  
[www.topstop.gr](http://www.topstop.gr)  
[info@topstop.gr](mailto:info@topstop.gr)

